

Data sheet

Modbus RTU inputs (In-A, In-B)

MULTICAL® 403

MULTICAL® 603

MULTICAL® 803

- Modbus RTU communication
- Communication speed up to 115200 bits/s
- Programmable data, communication speed and parity settings
- Two pulse inputs for additional water and electricity meters
- RS-485 galvanic isolated from meter
- Complies with Modbus implementation guide V1.02



Contents

Introduction	3
Applications	3
Installation	3
Cable connections	4
Communication from module	5
Modbus datagrams	6
Technical specifications	8
Ordering	9
Configuration	9
Displayed information	10
Modbus register mapping	11

Introduction

A high performance and flexible Modbus module for the MULTICAL® 403, MULTICAL® 603 and MULTICAL® 803 energy meters. The Modbus communication module enables the MULTICAL® energy meters to be integrated into a building automation system or to participate in industrial applications. The Modbus RTU is based on an RS-485 communication bus.

Applications

The Modbus module is designed with focus on high flexibility to fulfill a wide pallet of applications. The Modbus module supports rapid exchange of meter data, e.g. flow, energy and temperatures to facilitate monitoring and control tasks.

Analysis

The MULTICAL® energy meter supports high quantities of data, and all relevant data for analysis can be read out.

Alarms

The MULTICAL® info codes for general alarm, flow error, temperature error, water leakage, very high flow, air in the system, and wrong flow direction are available to the Modbus system.

Control and regulation

Data can be read out in intervals of few seconds at very high speed whereby the data can be used for control and regulation purposes.

Remote control of PQT Controller

Remote control of PQT controller is possible, as PQT Controllers limit settings can be read and written via Modbus commands. Thus the flow can be controlled by the building control system simply by setting one or more of the limit-settings in the PQT controller. All xx-yy-30x configurations contains the Modbus registers for the PQT functionality.

Installation

The module is easily mounted in the module slot of the meter. A configuration might be necessary if a specific slave address is required. Configuration of the Modbus slave address, bus speed and selection of datagram can be done with METERTOOL HCW through the optical read-out head on MULTICAL® or through the 10 pole connector on the module.

The module is power-supplied from the meter's internal 230 VAC or 24 VAC supply.

Cable connections

Terminals

Max cable size 1.5 mm²



Pulse input

- Terminal 65: Pulse In A/In-A (+)
- Terminal 66: Pulse In A/In-A (-)
- Terminal 67: Pulse In B/In-B (+)
- Terminal 68: Pulse In B/In-B (-)

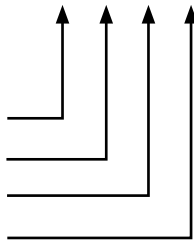

Modbus

- Terminal 138: RS-485 B/+
- Terminal 139: RS-485 GND
- Terminal 137: RS-485 A/-

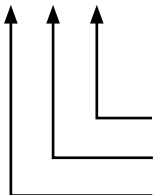

Pulse inputs

The module is equipped with two pulse inputs, In-A and In-B, to collect and accumulate pulses, e.g. from water and electricity meters.

The pulse inputs are physically placed on the module. However, the accumulation and logging of values are performed by the MULTICAL® calculator.

When installing a module with pulse inputs in slot 2 of MULTICAL® 603 and MULTICAL® 803, the pulse inputs will be registered in the meter as In-A2 and In-B2.

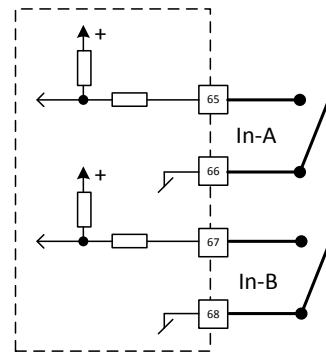

Data

The communication is RS485 based. To ensure proper communication a twisted shielded pair cable is mandatory. The shield must be connected to the GND Terminal. All devices in the Modbus RTU system should be connected in a line topology. The communication line must be terminated with 120 Ohm resistors between the A and B leads, at both ends.

Communication from module

Protocol

According to the Modbus over Serial Line, Specification and Implementation Guide V1.02.

Modbus addressing

The module may be addressed as a Modbus slave unit in the range from 1-247.

By default, the Modbus address equals the last three digits of the meter's customer number.

If the customer number of the meter results in an address larger than 247, only the last two digits are used for the Modbus address of the module.

Note: If the customer number of the meter ends with 000, the Modbus module automatically changes to address 247.

Note: The Modbus Slave ID or Bus Address is configured and stored in the MULTICAL®.

Communication speed

The module supports baud rates from 300 to 115200 baud. The parity and stop bits are to be selected as one of the following: no parity 1 stop, no parity 2 stop, even parity 1 stop or odd parity 1 stop.

Supported Modbus function codes

The module supports a subset of Modbus function codes for reading and writing. Generally, function codes and addresses are written in hexadecimal format shown by the prefix 0x.

Supported function codes and their possible exception codes:

- 0x03 Read Holding Registers with exception codes:
 - 0x02 – Illegal data address
 - 0x03 – Illegal data value
- 0x04 Read Input Registers with exception codes:
 - 0x02 – Illegal data address
 - 0x03 – Illegal data value
- 0x08 Diagnostics with exception code:
 - 0x01 – Illegal function
- Subcode 0x01 Restart with exception code:
 - 0x03 – Illegal data value
- 0x10 Write Multiple registers with exception code:
 - 0x02 – data address
 - 0x03 – Illegal data value
- 0x2B Encapsulated interface transport with exception code:
 - 0x01 – Illegal function
- Subcode 0x0E Read Device Identification with exception code:
 - 0x03 – Illegal data value
- 0x41 and 0x42 Reserved as Kamstrup Specific Function code

Modbus datagrams

The Modbus module supports the most common registers used for heating and cooling applications.

The following module configurations are available:

- xx-yy-300: Default datagram for MULTICAL®403, 603 and 803
- xx-yy-301: Legacy datagram makes the meter partly compatible with MULTICAL® 602
- xx-yy-302: MULTICAL® 803 datagram contains additional registers found only in the MULTICAL® 803 and MULTICAL® 803M.

The yy denotes the Baudrate and parity/stop bit selection in the configuration.

All datagrams are able to handle reading and writing of the PQT control-registers.

Default datagram	Legacy datagram	MULTICAL® 803
Flow V1 actual	Heat energy E1	Flow V1 actual
Flow V2 actual	Flow V1 actual	* Volume V1
Actual Power	Volume V1	Flow V2 actual
t1 actual	Actual Power	Actual Power
t2 actual	t1 actual	Actual Power 2 (E14/E16)
t3 actual	t2 actual	t1 actual
t4 actual	Pulse input A1	t2 actual
t1-t2 diff. temp.	Pulse input B1	t3 actual
P1 actual	Heat energy E1	t4 actual
P2 actual	Flow V1 actual	t1-t2 diff. temp.
Heat energy E1	Volume V1	P1 actual
Heat energy E2	Actual Power	P2 actual
Cooling energy E3	Heat energy E1	Heat energy E1
Inlet energy E4	Flow V1 actual	* Heat energy E1
Outlet energy E5	Volume V1	Heat energy E2
Tap water energy E6	Actual Power	Cooling energy E3
Tap water energy E7	t1 actual	* Heat energy E3
Energy E8	t2 actual	Inlet energy E4
Energy E9	Pulse input A1	Outlet energy E5
Energy E10	Pulse input B1	Tap water energy E6
Energy E11	Heat energy E1	Tap water energy E7
Tariff TA2	Flow V1 actual	Energy E8
Tariff TA3	Volume V1	Energy E9
Tariff TA4	Actual Power	Energy E10
Heat energy A1	Pulse input A1	Energy E11
Heat energy A2	Pulse input B1	Energy E12
Volume V1	Modul SW revision	Energy E13
Volume V2	Info code	Energy E14
Pulse input A1	ZERO	Energy E15
Pulse input B1	Cooling energy E3	Energy E16
Pulse input A2	Heat energy E1 - Month Log	Tariff TA2
Pulse input B2	Volume V1 - Month Log	Tariff TA3
COP	Cooling energy E3	Tariff TA4
t5 limit	ZERO	Heat energy A1
Power Input B1	Cooling energy E3	Heat energy A2
QP average time	ZERO	Volume V1

Default datagram	Legacy datagram	MULTICAL® 803
Tariff limit TL2	ZERO	Volume V2
Tariff limit TL3	Cooling energy E3	Pulse input A1
Tariff limit TL4	ZERO	Pulse input B1
Mass M1	Power max year	Pulse input A2
Mass M2	Tarif 2	Pulse input B2
Info code	Tarif 3	COP
Operating hours	Tarif limit 2	t5 limit
Error hour counter	Tarif limit 3	Power Input B1
Date (yy.mm.dd)	ZERO	QP average time
Time (hh.mm.ss)	Customer No. 1	Tariff limit TL2
Config No. 1	Serial No.	Tariff limit TL3
Config No. 2	ZERO	Tariff limit TL4
Config No. 3	ZERO	Mass M1
Config No. 4	ZERO	Mass M2
Customer No. 2	Operating hours	Mass M3
Customer No. 1		Mass M4
Serial No.		Info code
Meter type incl. SW edition		Operating hours
Meter Main/Sub type		Error hour counter
Meter SW revision		Date (yy.mm.dd)
		Time (hh.mm.ss)
		Config No. 1
		Config No. 2
		Config No. 3
		Config No. 4
		Customer No. 2
		Customer No. 1
		Serial No.
		Meter type incl. SW edition
		Meter Main/Sub type
		Meter SW revision
		Fluid type/Concentration

* High resolution registers

For detailed description of the datagrams, see data sheet [58101758](#).

Technical data

Physical

For installation in MULTICAL® 403, MULTICAL® 603 and MULTICAL® 803.

Mechanical data

Dimensions (L x W x D) 90 x 35 x 14 mm

Weight < 45g.

MULTICAL® Supply

 AC supply

Communication

Protocol Modbus RTU

Baud rates
 300 bit/s
 2400 bit/s
 9600 bit/s
 19200 bits/s
 38400 bits/s
 57600 bits/s
 76800 bits/s
 115200 bits/s

Parity, Stop bits
 No parity, 1 stop bits
 No parity, 2 stop bits
 Odd parity, 1 stop bits
 Even parity, 1 stop bits

Address range 1...247
 Default 19200, 8 data bits, even parity 1 stop bit

Data refresh rate

Data from the meter to the module are refreshed each time the meter completes an integration. Integration mode is defined by the meters L-code.

Bus Specific

Type RS-485, 2 wires + GND

Galvanic isolation > 2kV

Pulse inputs

Input type Contact input

Open voltage 3,6 V

Current ≤ 5 µA

Max cable length 10 m

Environment

Operational temperature 5 °C – 55 °C

Humidity 25 – 85 % RH non-condensing

Markings/approvals

CE, MID together with the type approval of MULTICAL® 403, MULTICAL® 603 and MULTICAL® 803.

Compatibility

Modbus over Serial Line, Specification and Implementation Guide V1.02.

Additional documentation

5512-2580

[58101758](#)

Modbus RTU conformance certificate, issued by MBS GmbH

Data sheet Modbus register mapping, detailed description.

Programming

Configuration/Firmware Via the optical readout head or the multipole connector on the module using METERTOOL HCW

Ordering

Description

Modbus RTU, inputs (In-A, In-B)
 USB configuration cable for H/C modules
 Optical read-out head w/USB
 METERTOOL HCW

Order No.

HC-003-67
 6699-035
 6699-099
www.kamstrup.com

Configuration

Product type of module	XX	Y	Y	ZZZ
Modbus RTU, inputs (In-A, In-B)	67	4	3	300
Communication speed				
300 baud			1	
2400 baud			2	
9600 baud			3	
19200 baud			4	
38400 baud			5	
57600 baud			6	
76800 baud			7	
115200 baud			8	
Parity/Stop bits				
No parity 1 stop bit			1	
No parity 2 stop bits			2	
Even parity 1 stop bit			3	
Odd parity 1 stop bit			4	
Data content configuration				
Default datagram				300
Legacy datagram				301
MULTICAL® 803 datagram				302
Reserved				ZZZ

Displayed information





Module information can be read by selecting TECH-loop on the MULTICAL® display.

Module in module slot 1: select menu 2-101 in TECH-loop

Module in module slot 2: select menu 2-201 in TECH-loop

Module in module slot 3: select menu 2-301 in TECH-loop

Module in module slot 4: select menu 2-401 in TECH-loop

Menu	Menu index	Information	Display example
2-x01	31	Module type and configuration	
2-x01-1	32	Module firmware and revision	
2-x01-2	33	Module serial number	
2-x01-3	34	Bus address	

Modbus register mapping

The various Modbus datagrams are described in details in the data sheet about Modbus registers, [58101758](#).

Modbus RTU, inputs (In-A, In-B)

MULTICAL® 403

MULTICAL® 603

MULTICAL® 803

Kamstrup A/S

Industrivej 28, Stilling
DK-8660 Skanderborg

T: +45 89 93 10 00

F: +45 89 93 10 01

info@kamstrup.com

kamstrup.com